

PRODUCT LINE-UP 2024

BOATS • CANOES • ACCESSORIES



ARKIP 530 BR • ARKIP 460 • SPORTSMAN 445 B/M/C • SPORTSMAN 400 • SPORTSMAN 355 • FISHING 440 • FISHING 410
INKAS 525 • INKAS 495 • INKAS 465 • INKAS 465L

GREETINGS FROM SWEDEN



Aluminium boats

ALUMINIUM BOATS FROM SMÅLAND

A FORM-STRETCHED HULL

Aluminium has yet another major advantage as regards, for example, designing bodywork, beams and, as here, hulls – it is exceedingly formable.

Linder aluminium boats are made using so-called “form stretching”. The sheet metal for the hull is shaped (stretched) around a form. This form produces the familiar, soft and harmonic lines that constitute one of our trademarks. This forming technology saves energy because it tempers most of our aluminium alloys. Consequently, the sheets do not need to be heat hardened.

Where other manufacturers use welding, or in the worst cases, riveting to join hull sections, Linder has a different approach. We join both sections using screws and a unique keel profile. The seal is so precise that, as neither light nor oxygen can get to the sealing compound, there is no ageing. Our production methods give a superior finish that has fewer joins and thus reduces the risks of leaks and wear.

LINDER ORIGINAL ACCESSORIES

Linder Original is a vast range of the highest quality functional accessories that make owning a Linder even easier. A cover, a replacement for a lost drain plug, motor mounts, oars, paddles... Or why not treat yourself to a solar cell unit for a Fishing 440?

Use this range guide to select the boat or canoe of your choice. All standard equipment is included in your purchase. This is an area where we often outperform our competitors. You can, of course, also select from the accessories in this guide.

www.linder.se

Visit our website for even more information and the latest news.



Our boats and canoes are approved by DNV – Det Norske Veritas (www.dnvgl.com).

Our boats are Securmark security marked. Securmark offers Scandinavia's most complete system for boat marking. Boats are marked with small microdots that contain an ID number. They are located at several places in the boat [www.securmark.se]. All costs for registering this security marking are paid by Linder. All you have to do is register your boat (over the internet or using the form that comes with the boat).



ARKIP 530 BR*

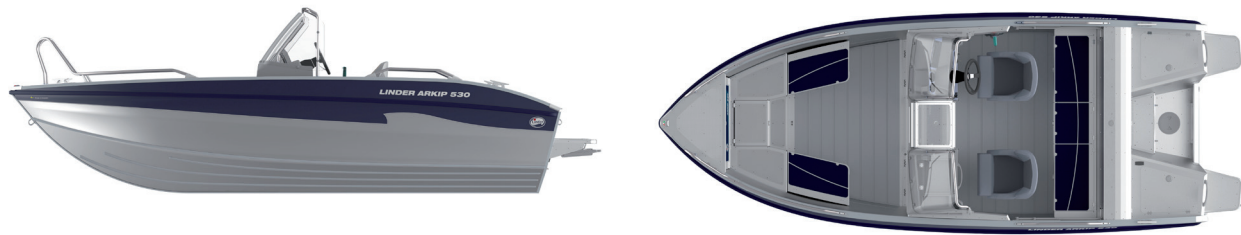

With a double hull and gunwale, a motor boat that planes easily and holds max. 6 people. The slender shape and 16° hull angle ensure a low planing threshold. This promises speed. Buoyancy in hull sides, a self-bailer and, obviously enough, a 2.7 mm aluminium hull give you a feeling of security, even if you happen to run aground. Three-year guarantee.

Art. no. 530000



SPECS

Length	530 cm
	576 cm with bathing platform
Width	214 cm
Total height	178 cm
Weight	610 kg
Max. weight with motor	849 kg
Interior height	67 cm
Hull height	112 cm
Hull thickness	2.7 mm
Hull angle	16°
Rec. motor	70-100 hp (51-74.6 kW)
Max. motor power	100 hp (74.6 kW)
Control cable length	4.80 m
Steering cable length	4.80 m
	(hydraulic steering)
Shaft length	Long
Max. load	600 kg
Max. no. people	6
Approved bow eye	Insurance class 3
CE marked for category	C Inshore

STANDARD EQUIPMENT

- Double console with fitted door and hydraulic steering
- Garmin GPS UHD 92SV Plus w/o XDCR
- Garmin Sidevü GT52 transducer, adjustable transducer mount
- Two gas-sprung flip-up comfort seats (vertically and laterally adjustable)
- Self-bailer
- Automatic bilge pump
- Bow foredeck suitable for electric motor
- Toe rail with easy-to-grip grab rails in anodised aluminium
- Anti-slip aluminium floor grid
- Two seat covers
- Stern/rear seat (removable) with seat pads
- 10 stowage compartments, incl. 3 lockable, two removable stowage spaces in the bow and one in the stern
- Stern cover with integrated foldaway cover box
- Bow seat with integrated step
- Bathing platform with bathing ladder
- Fixed fuel tank, 67 litres
- Room for two removable tanks
- C-tec socket
- Deutsch connector
- USB/12 V power outlet
- Navigation lights with LEDs in bow and stern (removable)
- Main power switch with circuit breakers
- "Navalloy" anode for both fresh and salt water
- Hardened front & rear mooring shackle, class 3
- Manual pump
- 4 bollards
- Fire extinguisher
- Drain plug
- Securmark security marking
- DNV approval

ACCESSORIES

- Water ski pylon
- Console cover
- Fishing/sun deck
- Bow seat pads
- Sun deck seat pads
- Tube rod holder
- Trolling rod holder
- Rod holder
- Fishing lure holder, aluminium
- Mug holder
- Mooring package
- Securing kit with chain (2.5 m)
- Storage cover
- Cockpit table
- Rail bucket

WE PRE-MOUNT RIGGING KIT

A Linder boat gives you the freedom to choose the motor supplier you prefer. In certain markets, the choice of motor may vary depending on the importer's partners.



NEW! See page 16



* BR stands for bow rider, a motor boat with a windscreen to protect people riding in the open bow.



ARKIP 460



CLASS WINNER – With sturdy toe rail, easy-to-grip grab rails, aluminium floor grid and ample passenger and storage space, a planing, family boat for max. 5 people. Ideal for a large number of free time activities such as waterskiing and sea/lake fishing. Arkkip 460 is also an excellent transport boat and is easy to trailer. Three-year guarantee.

Art. no. 460000



SPECS

Length	460 cm
Width	185 cm
Total height	142 cm
Weight	292 kg
Max. weight with motor	485 kg
Interior height	60 cm
Hull height	80 cm
Hull thickness	2.4 mm
Hull angle	12°
Rec. motor	30-50 hp (22-38 kW)
Max. motor power	50 hp (38 kW)
Control cable length	2.10 m
Steering cable length	2.70 m
Shaft length	Long
Max. load	515 kg
Max. no. people	5
Approved bow eye	Insurance class 3
CE marked for category	C Inshore

STANDARD EQUIPMENT

- Steering console with windscreen
- Garmin GPS UHD 92SV Plus w/o XDCR
- Garmin Sidevü GT52 transducer, adjustable transducer mount
- Rod box, 150 cm
- Automatic bilge pump
- Bow foredeck suitable for electric motor
- Toe rail with easy-to-grip grab rails in anodised aluminium
- Anti-slip aluminium floor grid
- Stern/rear seat
- Bow seat
- 5 stowage compartments, incl. 3 lockable
- Bathing ladder
- C-tec socket
- 12 V power outlet
- Navigation lights with LEDs in bow and stern (removable)
- Main power switch with circuit breakers
- "Navalloy" anode for both fresh and salt water
- Hardened front & rear mooring shackle, class 3
- 4 bollards
- Fire extinguisher
- Drain plug
- Securmark security marking
- DNV approval

ACCESSORIES

- Water ski pylon
- Left console
- Console cover
- Electric motor mount, stern
- Fishing/sun deck
- Stern seat pads
- Bow seat pads
- Sun deck seat pads
- Tube rod holder
- Trolling rod holder
- Rod holder
- Fishing lure holder, aluminium
- Mooring cover
- Stern cover, single console
- Stern cover, double console
- Windbreak, double console
- Battery holder floor placement
- Mug holder
- Bow rail rowlock holder
- Mooring package
- Securing kit with chain (2.5 m)
- Rail bucket
- Rod box
- Softfloor
- Bimini top

WE PRE-MOUNT RIGGING KIT

A Linder boat gives you the freedom to choose the motor supplier you prefer. In certain markets, the choice of motor may vary depending on the importer's partners.



NEW! See page 18



NEW! See page 15

SPORTSMAN 445 CATCH



A planing, fishing boat for lakes, sea and max. 3 people. Equipped with fishing platform. In developing 445 Catch, we collaborated with experienced sports fishers. The boat even has provision for a remotely controlled electric motor in the bow. Today's electric motors are operated via a remote control on the wrist, the boat turning on a sixpence. Special electric drive mount in the stern. Three-year guarantee.

Art. no. 445000C



SPECS		STANDARD EQUIPMENT	ACCESSORIES
Length	451 cm	- Steering console with windscreen	- Fishing chair (collapsible back, incl. column)
Width	175 cm	- Garmin GPS UHD 92SV Plus w/o XDCR	- Fishing deck mat
Total height	140 cm	- Garmin Sidevü GT52 transducer, adjustable transducer mount	- Electric motor mount, stern
Weight	252 kg	- Automatic bilge pump	- Stern seat pads
Max. weight with motor	407 kg	- Fishing rod box (step)	- Tube rod holder
Interior height	54 cm	- Fishing lure holder	- Trolling rod holder
Hull height	73 cm	- Fish ruler	- Rod holder
Hull thickness	2.0 mm	- Rod holder	- Fishing lure holder, aluminium
Hull angle	9°	- Bow foredeck suitable for electric motor	- Retrofit light set
Rec. motor	20-30 hp (14-23 kW)	- Toe rail with easy-to-grip grab rails in anodised aluminium	- Mooring cover
Max. motor power	30 hp (23 kW)	- Anti-slip aluminium floor grid	- Console cover
Control cable length	2.10 m	- Fishing chair mount	- Mug holder
Steering cable length	2.70 m	- 6 stowage compartments, incl. two lockable	- Bow rail rowlock holder
Shaft length	Long	- Rescue ladder	- Mooring package
Max. load	455 kg	- C-tec socket	- Securing kit with chain (2.5 m)
Max. no. people	3	- 12 V power outlet	- Rail bucket
Approved bow eye	Insurance class 3	- Main power switch with circuit breakers	- Softfloor
CE marked for category	C Inshore	- "Navalloy" anode for both fresh and salt water	
		- Hardened front & rear mooring shackle, class 3	
		- 4 bollards	
		- Drain plug	
		- Securmark security marking	
		- DNV approval	

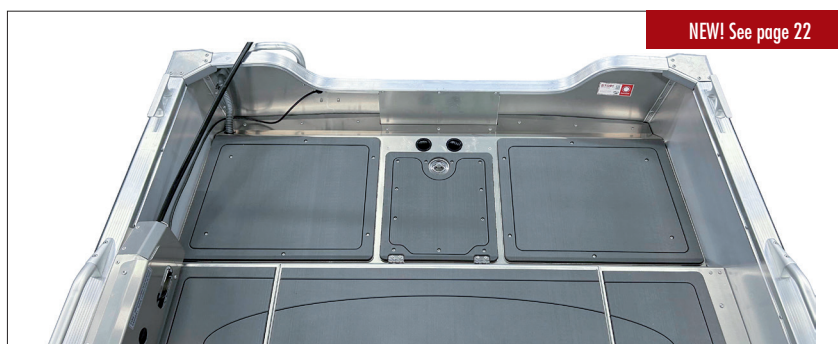



SPORTSMAN 445 MAX

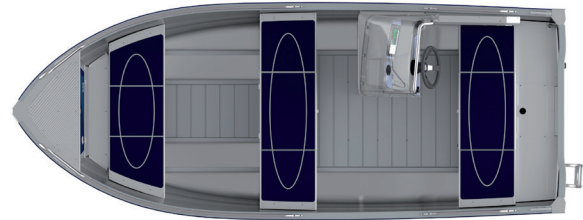

A planing, family boat, max. 4 people, suitable for sea/lake fishing as well as waterskiing. Stowage spaces in stern, midship seats and bow deck. 445 Max can also be equipped with a battery pack and, for example, a Torqeedo 10.0 kW electric drive (equivalent to a 20-hp petrol motor). Easy to trailer. Three-year guarantee.

Art. no. 445000M



SPECS		STANDARD EQUIPMENT	ACCESSORIES
Length	451 cm	- Steering console with windscreen	- Fishing platform
Width	175 cm	- Garmin GPS UHD 92SV Plus w/o XDCR	- Electric motor mount, stern
Total height	140 cm	- Garmin Sidevü GT52 transducer, adjustable transducer mount	- Seat pads, complete set
Weight	227 kg	- Automatic bilge pump	- Tube rod holder
Max. weight with motor	382 kg	- Bow foredeck suitable for electric motor	- Trolling rod holder
Interior height	54 cm	- Toe rail with easy-to-grip grab rails in anodised aluminium	- Rod holder
Hull height	73 cm	- Anti-slip aluminium floor grid	- Fishing lure holder, aluminium
Hull thickness	2.0 mm	- Stern seat	- Retrofit light set
Hull angle	9°	- Midship seat	- Mooring cover
Rec. motor	20-30 hp (14-23 kW)	- Bow seat	- Console cover
Max. motor power	30 hp (23 kW)	- 4 stowage compartments, incl. 2 lockable	- Battery holder floor placement
Control cable length	1.80 m	- Rescue ladder	- Mug holder
Steering cable length	2.40 m	- 12 V power outlet	- Bow rail rowlock holder
Shaft length	Long	- Main power switch with circuit breakers	- Mooring package
Max. load	455 kg	- "Navalloy" anode for both fresh and salt water	- Securing kit with chain (2.5 m)
Max. no. people	4	- Hardened front & rear mooring shackle, class 3	- Rail bucket
Approved bow eye	Insurance class 3	- 4 bollards	
CE marked for category	C Inshore	- Drain plug	
		- Securmark security marking	
		- DNV approval	

WE PRE-MOUNT RIGGING KIT

A Linder boat gives you the freedom to choose the motor supplier you prefer. In certain markets, the choice of motor may vary depending on the importer's partners.





SPORTSMAN 445 BASIC

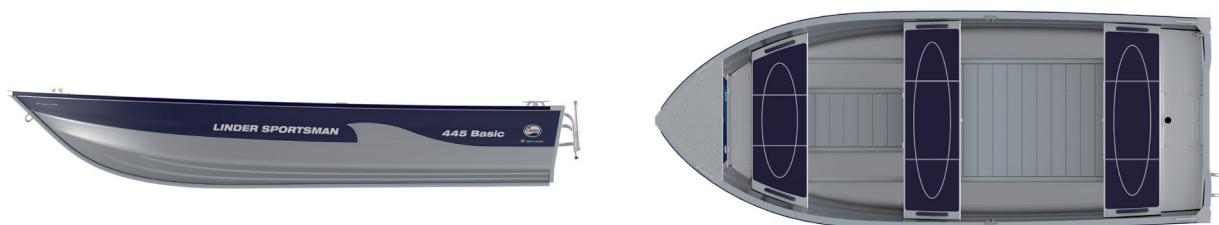

A planing motor boat suitable for day trips, sea/lake fishing and max. 4 people. Stowage space in the stern and midship seats. 445 Basic comes with aluminium oars. Easy to trailer. Three-year guarantee.

Art. no. 445000B



SPECS

Length	451 cm
Width	175 cm
Total height	77 cm
Weight	189 kg
Max. weight with motor	329 kg
Interior height	54 cm
Hull height	73 cm
Hull thickness	2.0 mm
Hull angle	9°
Rec. motor	10-20 hp (7-15 kW)
Max. motor power	20 hp (15 kW)
Shaft length	Long
Max. load	474 kg
Max. no. people	4
Approved bow eye	Insurance class 3
CE marked for category	C Inshore

STANDARD EQUIPMENT

- Anti-slip aluminium floor grid
- Automatic bilge pump
- Bow foredeck suitable for electric motor
- 9' aluminium oars
- Oar blade holder
- Articulated rowlock
- Stern seat
- Midship seat
- Bow seat
- 3 stowage compartments, of which 2 lockable
- Rescue ladder
- "Navalloy" anode for both fresh and salt water
- Hardened front & rear mooring shackle, class 3
- 4 bollards
- Drain plug
- Securmark security marking
- DNV approval

ACCESSORIES

- Fishing platform
- Grab rail, bow pulpit rail
- Electric motor mount, stern
- Seat pads, complete set
- Tube rod holder
- Trolling rod holder
- Fishing lure holder, aluminium
- Sonar transducer mount, adjustable
- Rail
- Retrofit light set
- Mooring cover
- Battery holder floor placement
- Mooring package
- Securing kit with chain (2.5 m)
- Rail bucket





SPORTSMAN 400

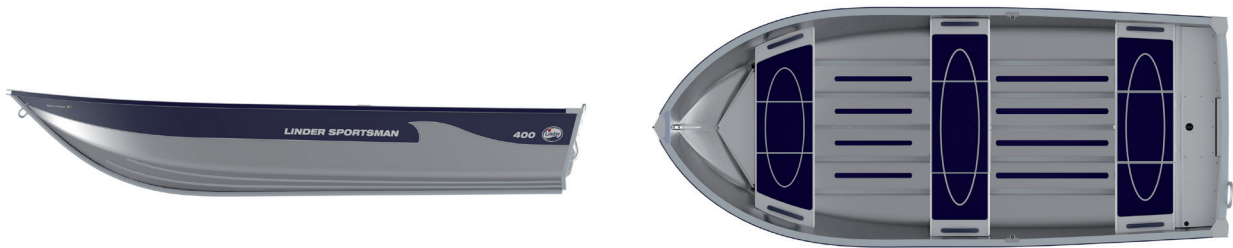

A planing, family boat for lakes, skerries, coastal waters and max. 4 people. With a steering console, the Sportsman 400 is also appropriate for waterskiing (lighter people). Easy to trailer. Three-year guarantee.

Art. no. 400000



SPECS		STANDARD EQUIPMENT	ACCESSORIES
Length	401 cm	- 9' aluminium oars	- Steering console
Width	164 cm	- Oar blade holder	- Steering console windscreen
Weight	125 kg	- Articulated rowlock	- Bow foredeck for electric motor
Max. weight with motor	281 kg	- Stern seat	- Electric motor mount, stern
Interior height	60 cm	- Midship seat	- Grab rail, bow pulpit rail
Hull height	63 cm	- Bow seat	- Aluminium flooring
Hull thickness	1.8 mm	- Two lockable stowage compartments	- Wooden flooring
Hull angle	8°	- Rescue ladder	- Tube rod holder
Rec. motor	6-10 hp (4-8 kW)	- "Navalloy" anode for both fresh and salt water	- Trolling rod holder
with steering console	15-20 hp (11-15 kW)	- Bow and stern mooring eyes	- Fishing lure holder, aluminium
Max. motor power	20 hp (15 kW)	- Drain plug	- Sonar transducer mount, adjustable
Control cable length (Side console)	1.80 m	- Securmark security marking	- Rail
Control cable length (Mid console)	2.70 m	- DNV approval	- Retrofit light set
Steering cable length (Side console)	2.40 m		- Mooring cover
Steering cable length (Mid console)	3.30 m		- Battery holder floor placement
Shaft length	Long		- Mooring package
Max. load	410 kg		- Securing kit with chain (2.5 m)
Max. no. people	4		- Bollard
Approved bow eye	Insurance class 3		- Automatic bilge pump
CE marked for category	D Sheltered waters		- Smart wave/Länsman bilge pump
			- Rail bucket



NEW! See page 15



SPORTSMAN 355

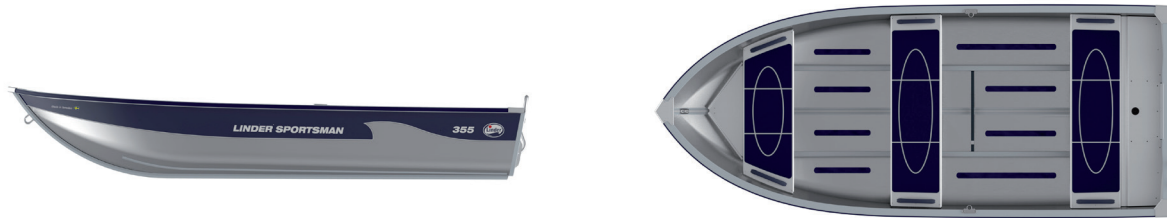

A planing motor boat for lakes, small/larger rivers and max. 3 people. Also suitable for young people. Thanks to its seaworthiness and manoeuvrability, the Sportsman 355 can advantageously be used as a rescue boat. Easy to trailer. Three-year guarantee.

Art. no. 355000



SPECS

Length	355 cm
Width	146 cm
Weight	84 kg
Max. weight with motor	167 kg
Interior height	51 cm
Hull height	54 cm
Hull thickness	1.7 mm
Hull angle	2°
Rec. motor	6-8 hp (4-6 kW)
Max. motor power	8 hp (6 kW)
Shaft length	Short
Max. load	310 kg
Max. no. people	3
Approved bow eye	Insurance class 3
CE marked for category	D Sheltered waters

STANDARD EQUIPMENT

- 8' aluminium oars
- Oar blade holder
- Articulated rowlock
- Stern seat
- Midship seat
- Bow seat
- Rescue ladder
- Bow and stern mooring eyes
- Drain plug
- Securmark security marking
- DNV approval

ACCESSORIES

- Electric motor mount, stern
- Grab rail, bow pulpit rail
- Aluminium flooring
- Wooden flooring
- Tube rod holder
- Trolling rod holder
- Fishing lure holder, aluminium
- Sonar transducer mount, adjustable
- Retrofit light set
- Mooring cover
- Anode kit
- Mooring package
- Securing kit with chain (2.5 m)
- Bollard
- Smart wave/Länsman bilge pump
- Rail bucket

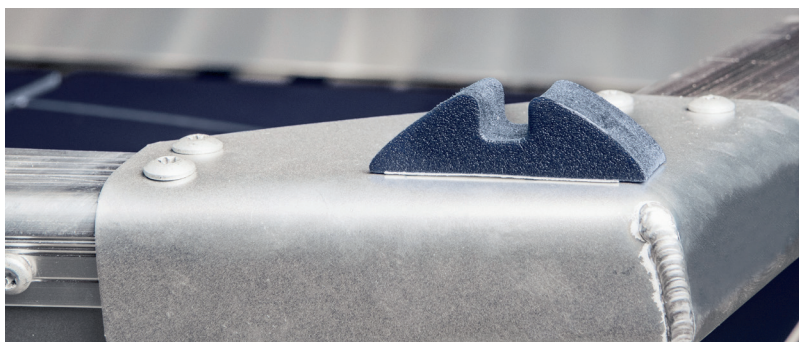



FISHING 440



BEST SELLER – A light but stable, clinker-built rowboat that is ideal for lakes, skerries, coastal waters and max. 4 people. Fishing 440 has the market's lowest petrol consumption – 0.11 litres per sea mile with one person at seven knots. Can advantageously be equipped with our solar cell unit. Easy to row. Easy to trailer. Three-year guarantee.

Art. no. 440000



SPECS

Length	431 cm
Width	164 cm
Weight	94 kg
Max. weight with motor	149 kg
Interior height	54 cm
Hull height	60 cm
Hull thickness	1.7 mm
Rec. motor	2.5-5 hp (1.8-4 kW)
Max. motor power	5 hp (4 kW)
Shaft length	Short
Max. load	390 kg
Max. no. people	4
Approved bow eye	Insurance class 3
CE marked for category	D Sheltered waters

STANDARD EQUIPMENT

- 9' aluminium oars
- Oar blade holder
- Safety rowlock
- Stern seat
- Midship seat
- Bow seat
- Two lockable stowage compartments
- Rescue ladder
- Bow and stern mooring eyes
- Drain plug
- Securmark security marking
- DNV approval

ACCESSORIES

- Solar cell pack
- Electric motor mount, stern
- Grab rail, bow pulpit rail
- Wooden flooring
- Tube rod holder
- Trolling rod holder
- Fishing lure holder, aluminium
- Sonar transducer mount, adjustable
- Retrofit light set
- Tiller extender/telescopic outboard motor handle
- Mooring cover
- Anode kit
- Mooring package
- Securing kit with chain (2.5 m)
- Bollard
- Automatic bilge pump
- Smart wave/Länsman bilge pump
- Rail bucket

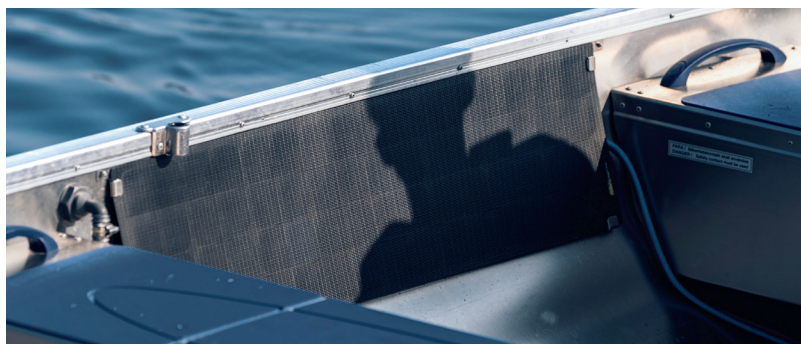



FISHING 410



A light, clinker-built rowboat for lakes and max. 3 people. Simple for one person to launch and retrieve. Fuss-free transport between lakes. Easy to row. Easy to trailer. Three-year guarantee.

Art. no. 410000



SPECS

Length	403 cm
Width	156 cm
Weight	75 kg
Max. weight with motor	107 kg
Interior height	57 cm
Hull height	63 cm
Hull thickness	1.7 mm
Rec. motor	2.5-3.5 hp (1.8-2.7 kW)
Max. motor power	3.5 hp (2.7 kW)
Shaft length	Short
Max. load	290 kg
Max. no. people	3
Approved bow eye	Insurance class 3
CE marked for category	D Sheltered waters

STANDARD EQUIPMENT

- 8.5' aluminium oars
- Oar blade holder
- Safety rowlock
- Stern seat
- Midship seat
- Bow seat
- Rescue ladder
- Bow and stern mooring eyes
- Drain plug
- Securmark security marking
- DNV approval

ACCESSORIES

- Electric motor mount, stern
- Grab rail, bow pulpit rail
- Wooden flooring
- Tube rod holder
- Trolling rod holder
- Fishing lure holder, aluminium
- Sonar transducer mount, adjustable
- Retrofit light set
- Tiller extender/telescopic outboard motor handle
- Mooring cover
- Anode kit
- Mooring package
- Securing kit with chain (2.5 m)
- Bollard
- Smart wave/Länsman bilge pump
- Rail bucket



RECOMMENDED MOTORS

		ARKIP 530 BR	ARKIP 460	SPORTSMAN 445 CATCH	SPORTSMAN 445 MAX	SPORTSMAN 445 BASIC	SPORTSMAN 400	SPORTSMAN 355	FISHING 440	FISHING 410
Electric drive Yamaha M12	Full power								3 knots	3 knots
	Reduced power approx. 20-25%								2 knots	2 knots
Electric drive Yamaha M26	Full power								4 knots	4 knots
	Reduced power approx. 20-25%								3 knots	3 knots
2.5 hp	1 person								7 knots ¹⁾	8 knots 4,800 rpm ¹⁾
	2 people								6 knots ¹⁾	5 knots 4,900 rpm ¹⁾
Electric drive Torqeedo 1103 CS	Full power								5 knots ²⁾	
	Reduced power approx. 20-25%								3 knots ²⁾	
4 hp	1 person								9 knots 5,100 rpm ¹⁾	
	2 people								8 knots 4,200 rpm ¹⁾	
5 hp	1 person								11 knots 5,500 rpm ¹⁾	
	2 people								8 knots 5,400 rpm ¹⁾	
6 hp	1 person						17 knots 5,600 rpm	15 knots 5,700 rpm		
	2 people						13 knots 5,200 rpm	11 knots 5,300 rpm		
8 hp	1 person						19 knots 5,600 rpm	19 knots 5,700 rpm		
	2 people						16 knots 5,200 rpm	16 knots 5,300 rpm		
10 hp	1 person					18 knots 5,800 rpm ¹⁾	21 knots 5,600 rpm			
	2 people					15 knots 5,450 rpm ¹⁾	18 knots 5,400 rpm			
15 hp	1 person					22 knots 6,100 rpm ¹⁾	24 knots 5,800 rpm ³⁾			
	2 people					19 knots 5,600 rpm	22 knots 5,700 rpm ³⁾			
Electric drive Torqeedo 10.0	1 person				17 knots ²⁾					
	2 people				15 knots ²⁾					
20 hp	1 person					24 knots 6,100 rpm ¹⁾	25 knots 6,000 rpm ³⁾			
	2 people			19 knots 5,500 rpm	20 knots 5,500 rpm	22 knots 5,700 rpm	24 knots 5,600 rpm ³⁾			
	4 people			16 knots 5,300 rpm	17 knots 5,300 rpm	18 knots 5,500 rpm				
25 hp	2 people			24 knots 5,800 rpm ¹⁾	25 knots 5,950 rpm ¹⁾					
	4 people			21 knots 5,500 rpm ¹⁾	23 knots 5,700 rpm ¹⁾					
30 hp	1 person			27 knots 5,900 rpm ¹⁾	26 knots 6,200 rpm					
	2 people		26 knots 6,100 rpm ¹⁾	25 knots 5,700 rpm ¹⁾	25 knots 6,100 rpm					
	4 people		25 knots 6,000 rpm ¹⁾		24 knots 5,300 rpm					
40 hp	2 people		30 knots 5,700 rpm ¹⁾							
	4 people		28 knots 5,300 rpm ¹⁾							
50 hp	2 people		32 knots 5,800 rpm ¹⁾							
	4 people		30 knots 5,400 rpm ¹⁾							
80 hp	2 people	33 knots 5,300 rpm ¹⁾								
	4 people	32 knots 5,300 rpm ¹⁾								
100 hp	2 people	38 knots 5,300 rpm								
	4 people	35 knots 5,300 rpm								

BOAT DATA

	ARKIP 530 BR	ARKIP 460	SPORTSMAN 445 CATCH	SPORTSMAN 445 MAX	SPORTSMAN 445 BASIC	SPORTSMAN 400	SPORTSMAN 355	FISHING 440***	FISHING 410
LENGTH	530 cm (576 cm with bathing platform)	460 cm	451 cm	451 cm	451 cm	401 cm	355 cm	431 cm	403 cm
WIDTH	214 cm	185 cm	175 cm	175 cm	175 cm	164 cm	146 cm	164 cm	156 cm
TOTAL HEIGHT	178 cm	142 cm	140 cm	140 cm	77 cm	63 cm	54 cm	60 cm	63 cm
WEIGHT	610 kg	292 kg	252 kg	227 kg	189 kg	125 kg	84 kg	94 kg	75 kg
MAX. WEIGHT WITH MOTOR	849 kg	485 kg	407 kg	382 kg	329 kg	281 kg*	167 kg	149 kg	107 kg
INTERIOR HEIGHT	67 cm	60 cm	54 cm	54 cm	54 cm	60 cm	51 cm	54 cm	57 cm
HULL HEIGHT	112 cm	80 cm	73 cm	73 cm	73 cm	63 cm	54 cm	60 cm	63 cm
HULL THICKNESS	2.7 mm	2.4 mm	2.0 mm	2.0 mm	2.0 mm	1.8 mm	1.7 mm	1.7 mm	1.7 mm
HULL ANGLE	16°	12°	9°	9°	9°	8°	2°	–	–
REC. MOTOR	70-100 hp (51-74.6 kW)	30-50 hp (22-38 kW)	20-30 hp (14-23 kW)	20-30 hp (14-23 kW)	10-20 hp (7-15 kW)	6-10 hp (4-8 kW) 15-20 hp (11-15 kW)**	6-8 hp (4-6 kW)	2.5-5 hp (1.8-4 kW)	2.5-3.5 hp (1.8-2.7 kW)
REC. TORQUEEDO ELECTRIC DRIVE				E.g Torqeedo Cruise 10.0 R (10.0 kW)				E.g Torqeedo Travel 11103 CS (1,100 W)	
MAX. MOTOR POWER	100 hp (74.6 kW)	50 hp (38 kW)	30 hp (23 kW)	30 hp (23 kW)	20 hp (15 kW)	20 hp (15 kW)	8 hp (6 kW)	5 hp (4 kW)	3.5 hp (2.7 kW)
CONTROL CABLE LENGTH	4.80 m	2.10 m	2.10 m	1.80 m		Side console 1.80 m Mid console 2.70 m			
STEERING CABLE LENGTH	4.80 m (hydraulic steering)	2.70 m	2.70 m	2.40 m		Side console 2.40 m Mid console 3.30 m			
SHAFT LENGTH	Long	Long	Long	Long	Long	Long	Short	Short	Short
MAX. LOAD	600 kg	515 kg	455 kg	455 kg	474 kg	410 kg	310 kg	390 kg	290 kg
MAX. NO. PEOPLE	6	5	3	4	4	4	3	4	3
APPROVED BOW EYE	Insurance class 3	Insurance class 3	Insurance class 3	Insurance class 3	Insurance class 3	Insurance class 3	Insurance class 3	Insurance class 3	Insurance class 3
CE MARKED FOR CATEGORY	C – Inshore	C – Inshore	C – Inshore	C – Inshore	C – Inshore	D – Sheltered waters	D – Sheltered waters	D – Sheltered waters	D – Sheltered waters
MAX. SPEED	2 people, 100 hp motor gives approx. 38 knots	2 people, 50 hp motor gives approx. 32 knots	2 people, 30 hp motor gives approx. 25 knots	1 person, 30 hp motor gives approx. 26 knots	1 person, 20 hp motor gives approx. 24 knots	1 person, 20 hp motor gives approx. 25 knots	1 person, 8 hp motor gives approx. 19 knots	1 person, 5 hp motor gives approx. 11 knots	1 person, 2 hp motor gives approx. 8 knots
STANDARD EQUIPMENT	9-inch GPS/sonar, double console with door, gas-sprung flip-up comfort seats (vertically and laterally adjustable), fixed tank (67 l), hydraulic steering, self-bailer, integrated step, stern seat pads, foldaway cover with box, automatic bilge pump, lights, rail, grab rails, bathing ladder, bathing platform, anti-slip aluminium flooring, bollard, sacrificial anode, fire extinguisher, drain plug, Securmark security marking	9-inch GPS/sonar, automatic bilge pump, light, railing, grab rails, bathing ladder, anti-slip aluminium flooring, bollard, sacrificial anode, fire extinguisher, drain plug, Securmark security marking	9-inch GPS/sonar, fishing lure holder, fishing chair mount, bow fore deck, railing, grab rail, automatic bilge pump, rescue ladder, rod holder, wide aluminium flooring, bollard, sacrificial anode, drain plug, Securmark security marking	9-inch GPS/sonar, bow fore deck, railing, grab rails, automatic bilge pump, bathing ladder, wide aluminium flooring, bollard, sacrificial anode, drain plug, Securmark security marking	Bow fore deck, aluminium oars, automatic bilge pump, bathing ladder, aluminium flooring, rowlock, oar blade holder, sacrificial anode, drain plug, Securmark security marking	Aluminium oars, rescue ladder, rowlock, oar blade holder, sacrificial anode, drain plug, Securmark security marking	Aluminium oars, rescue ladder, rowlock, oar blade holder, drain plug, Securmark security marking	Aluminium oars, rescue ladder, rowlock, oar blade holder, drain plug, Securmark security marking	Aluminium oars, rescue ladder, rowlock, oar blade holder, drain plug, Securmark security marking

*Incl. steering console and 20-hp motor.

**With steering console.

***Fishing 440 has the market's lowest petrol consumption – 0.11 litres per sea mile with 1 person at 7 knots.

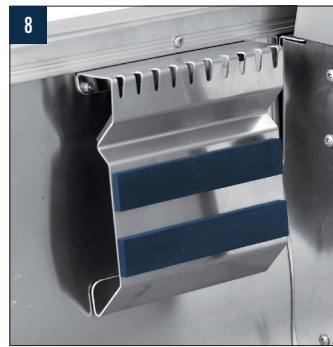
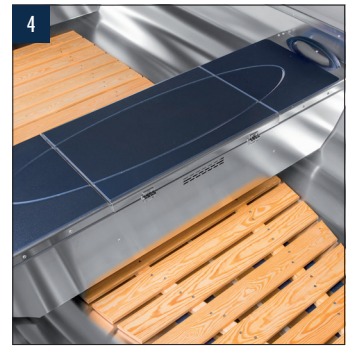

ACCESSORIES

	530BR	460	445B	445M	445C	400	355	440	410
1 "NAVALLOY" ANODE KIT Suitable for both fresh and salt water. Art. no. 712740	•	•	•	•	•	•	•	•	•
2 BOAT CART (MAX. LOAD 150 KG) Robust, aluminium design. Wheels have ball bearings and solid tyres. Art. no. 405000							•	•	•
3 RAIL MOUNT Mount suitable for GPS, trolling rod holder, downrigger, etc. Art. no. 712000	•	•	•	•	•	•	•	•	•
4 WOODEN FLOORING Art. no. 619355 Art. no. 619401 (From 2007) Art. no. 619400 (Up to 2006) Art. no. 619410 Art. no. 619440							•		•
5 ALUMINIUM FLOORING Art. no. 610355 Art. no. 610400						•			

	530BR	460	445B	445M	445C	400	355	440	410
6 DRAIN PLUG (STANDARD) Art. no. 621000	•	•	•	•	•	•	•	•	•
7 RAIL BUCKET New improved design. Marine-blue, plastic bucket (UV- protection) with blue strap handle and aluminium brackets for hanging on the rail. Holds 12 litres. Art. no. 622000	•	•	•	•	•	•	•	•	•
8 FISHING LURE HOLDER, ALUMINIUM Art. no. 211074 (Standard on 445 Catch)	•	•	•	•	•	•	•	•	•
9 ELECTRIC MOTOR MOUNT (For aluminium motor plate.) Art. no. 712009 Art. no. 712010 <i>Does not fit with water ski pylon Arkip 460.</i>						•	•	•	•

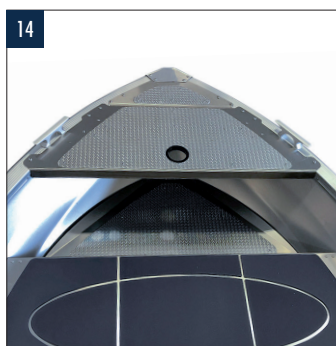
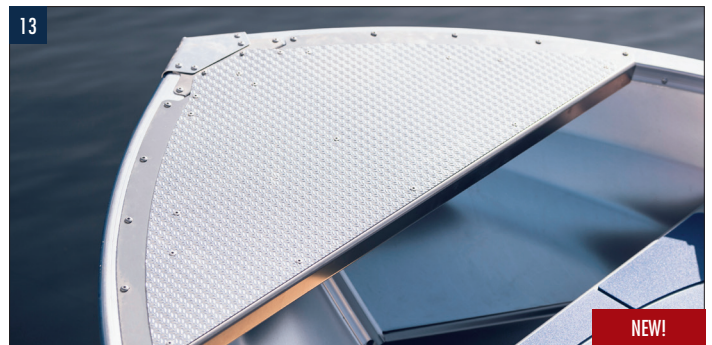
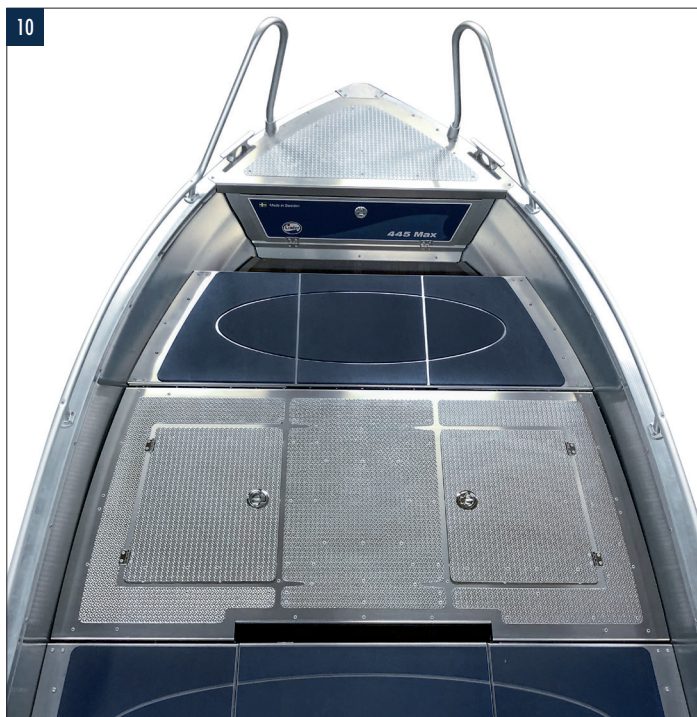

ACCESSORIES

	530BR	460	445B	445M	445C	400	355	440	410
10 FISHING PLATFORM Made of aluminium/chequered plate with hatches. (Can be used with fishing chair.) Art. no. 712026			•	•					
11 FISHING CHAIR, COLLAPSIBLE BACK New design. Includes chair column and base. Fits 530 BR, 460, 445 Basic and 445 Max with fishing platform/deck and fishing chair mount. Art. no. 719003	•	•	•	•	•				
12 FISHING CHAIR MOUNT Can be fitted in the fishing platform/deck that is an accessory for 530 BR, 460, 445 Basic and 445 Max. Art. no. 719004	•	•	•	•					
13 BOW DECK FOR ELECTRIC MOTOR, SPORTSMAN 400. Made of aluminium/chequered plate. Dimensions: 412 mm x 1,047 mm. For bow mounting of electric motor. Includes aluminium, electric motor mounting plate. Art. no. 712022						•			

	530BR	460	445B	445M	445C	400	355	440	410
14 BOW DECK FOR ELECTRIC MOTOR, 445 B/M Made of aluminium/chequered plate. Includes electric motor mounting plate. Fits 445 Basic up to 2019 (standard as of 2020) Fits 445 Max up to 2013 (standard as of 2014) Art. no. 712021			•	•					
15 SONAR TRANSDUCER MOUNT Aluminium. Adjustable. Height: 280 mm, width: 80 mm. Mounts on transom. Art. no. 712008		•	•	•	•	•	•	•	•
16 TABLE FOR LINDER 530 ARKIP Oval cockpit table with integrated cup holders. Supplied with table stand, colander bracket and assembly instructions. Dimensions 760 x 460mm. Art. no. 719007	•								
17 ROD BOX ARKIP 460 Made of aluminium, with plastic tubes fitting two rods with a length of 2.40m. Blue seat pads are included (Softfloor in photo is not included). Mounted port side between stern and bow. Measurements: 1220x400x400mm Art. no 712750		•							



NEW!

ACCESSORIES

	530BR	460	445B	445M	445C	400	355	440	410
1 BOW GRAB RAIL/"SHARK FIN" Width: 37 cm. Height: 46 cm. Art. no. 628000			•		•	•	•	•	•
2 BOW GRAB RAIL/"SHARK FIN" Fits Sportsman 445 Basic and 400 with mounted bow deck. Anodized aluminum. Width 37 cm. Height 46 cm. Screwed to the railing and to the bow deck. Art. no. 628100			•		•				
3 BLUE, PLASTIC HANDLE (STANDARD) Art. no. 811269			•		•	•	•	•	•
4 SPRAY COVER, DRIVABLE Max. speed with car 30 kph. Grey acrylic fabric. Art. no. 302445			•						
5 SINGLE CONSOLE STERN COVER, DRIVABLE Max. speed with car 30 kph. Grey acrylic fabric. Art. no. 302460 (From 2015) Art. no. 302471 (Up to 2014) <i>Does not fit with left-hand console or water ski pylon.</i>		•							

	530BR	460	445B	445M	445C	400	355	440	410
6 DOUBLE CONSOLE STERN COVER, DRIVABLE Max. speed with car 30 kph. Grey acrylic fabric. Art. no. 302462 (From 2015) Art. no. 302470 (Up to 2014) <i>Does not fit with water ski pylon.</i>			•						
7 BASIC COVER, MOORING, GREY POLYESTER Art. no. 302446 Art. no. 302356 Art. no. 302401 Art. no. 302411 Art. no. 302441			•	•	•		•		•
8 BASIC COVER, MOORING, GREY POLYESTER Art. no. 302461 <i>Does not fit with water ski pylon.</i>		•							
9 STORAGE COVER ARKIP 530 Storage cover to protect the inside of the boat when it is in port and when stored, e.g. on a trailer. Light gray vinyl. Maximum speed by car 30 km/h. Art. no. 302530	•								

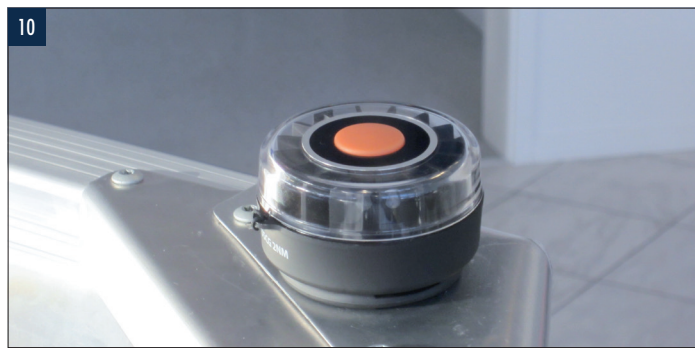
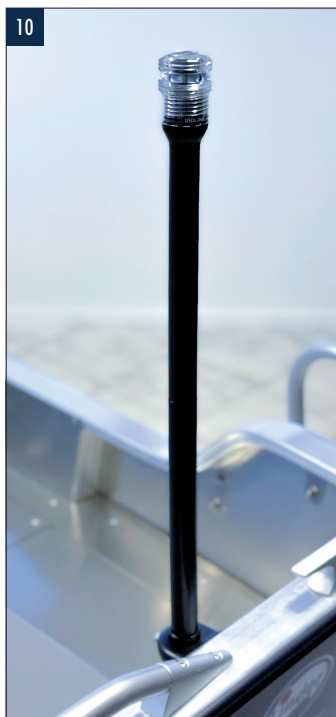

ACCESSORIES

10 NAVIGATION LIGHT SET

Light set, LEDs. For retrofitting to small motor boats.
Battery-powered.
1 white all-around light (for stern fitting).
1 green/red/white (for bow fitting).
1 telescopic stand, 100 cm.
1 stand mount.
Acid-resistant stainless steel screws included.
Art. no. 712800

530BR
460
445B
445M
445C
400
355
440
410

• • • • • • •

11 SECURITY KIT

(Insurance class 3 padlock with 2.5 m chain & sleeve.)
Art. no. 626000

• • • • • • • •

12 LÄNSMAN BILGE PUMP

Automatic bilge pump that fits on the mooring line.
Easy to install. Practical to take along. Locks into place.
Can pump out up to 2,500 litres a day.
Art. no. 606600

• • • • • • • •

13 ELECTRIC BILGE PUMP SET

For boats with steering console 717400.
Includes: Automatic bilge pump, cable trunk, mounting plate and contact breaker for the steering console.
Art. no. 718000

530BR
460
445B
445M
445C
400
355
440
410

•

14 ELECTRIC BILGE PUMP SET

For boats without steering console. Includes: Automatic bilge pump, cable trunk, mounting plate and contact breaker.
Art. no. 718001

•

15 BILGE PUMP – SMART, WAVE-OPERATED

To get water out of the boat, simply hang the pump over the side (pump body floating on the water). Wave action then operates the pump.
Art. no. 606500

• • • • • • • •

16 ELECTRIC BILGE PUMP SET

Includes: Automatic bilge pump, cable trunk, mounting plate and contact breaker.
Art. no. 718002

•

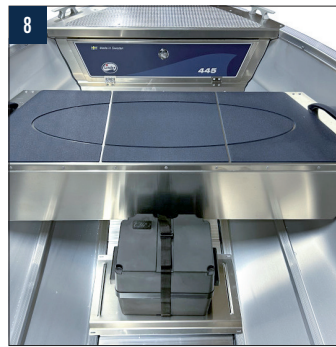
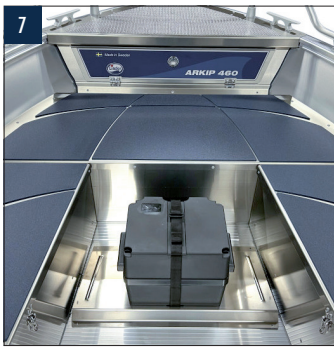
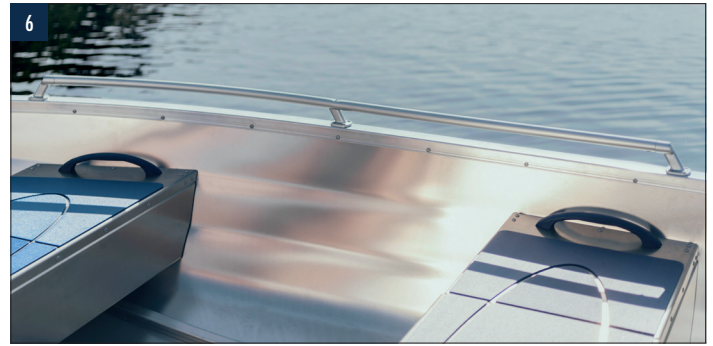
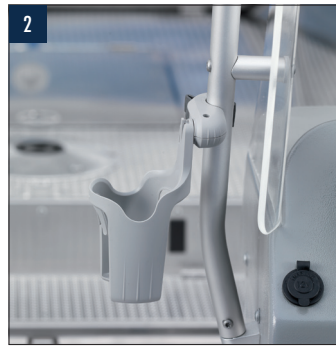

NEW!

ACCESSORIES

	530BR	460	445B	445M	445C	400	355	440	410
1 FISHING DECK MAT 6 mm thick polypropylene, UV resistant and draining. Art. no. 627500					•				
2 MUG HOLDER 2 pack, grey plastic. Art. no. 712650	•	•	•	•					
3 BOLLARD FOR RETROFITTING Anodised aluminium, 165 mm. Sold per unit Art. no. 623020						•	•	•	•
4 CONSOLE 460, LEFT-HAND Art. no. 714460 (From 2015) Art. no. 714461 (Up to 2014)		•							
5 CONSOLE COVER Grey acrylic fabric. For right-hand console. Art. no. 302464 (From 2015) Art. no. 302467 (Up to 2014)		•	•	•	•				
For left-hand console. Art. no. 302466 (From 2015) Art. no. 302468 (Up to 2014)		•	•						

	530BR	460	445B	445M	445C	400	355	440	410
6 RAIL Grip-friendly rail for mounting of accessories. Easy to retrofit. Set of four parts. Aluminium. Art. no. 712030			•		•				
7-8 BATTERY HOLDER FLOOR Battery holder for Sportsman 400, 445 Basic, Max and Arkip 460 for mounting an extra battery box on the floor. Consists of aluminum mounting plate and battery box Art. no. 712013 Art. no. 712014 Art. no. 712015								•	
9 BIMINI TOP Made of gray boat canopy fabric Sunbrella Plus. Incl. aluminum frames and assembly details. Foldable, UV protected and developed for marine use. Protects against sun and rain. Incl. 4 adjustable nylon straps. Also works with water skiing tow bar. Length: 2.0 m Width: 1.75 m Height: 1.8 m (from hull) Art. no. 302472									•

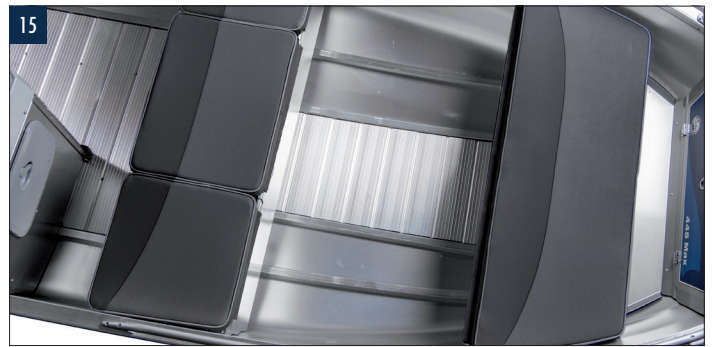
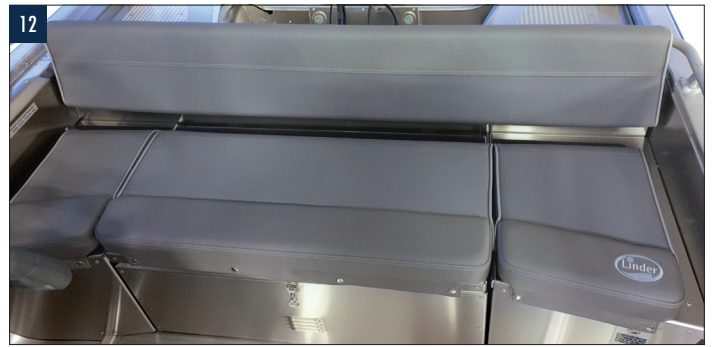

ACCESSORIES

	530BR	460	445B	445M	445C	400	355	440	410
10 RESCUE LADDER (RETROFIT) Foldaway, aluminium rescue ladder. Art. no. 712730 Art. no. 712720 Art. no. 712710 Art. no. 712700						•		•	
11 SEAT PADS, STERN Stern seat pads. Art. no. 627446				•					
12 STERN SEAT PAD SET - Back pad - Side pad, starboard - Centre pad - Side pad, port Art. no. 627460		•							
13 BOW SEAT PAD SET - Side pad, starboard - Side pad, port - Bow seat pads and back pad Art. no. 627530	•								

	530BR	460	445B	445M	445C	400	355	440	410
14 BOW SEAT PAD SET - Side pad, starboard - Pad, bow - Side pad, port Art. no. 627461			•						
15 SEAT PADS, COMPLETE SET - Stern seat pads - Midship seat pads - Bow seat pad Not suitable for combining with bow stowage deck, art. no. 712020. Art. no. 627445			•	•					

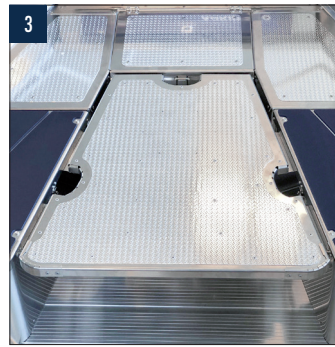
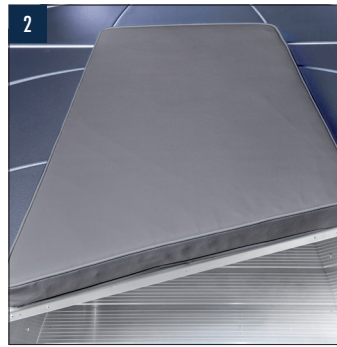
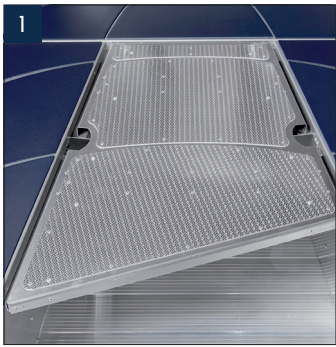

ACCESSORIES

	530BR	460	445B	445M	445C	400	355	440	410
1 COMBINED FISHING/SUN DECK, 460 In chequered plate. Can be combined with fishing chair. Art. no. 712025		•							
2 SEAT PAD FOR FISHING/SUN DECK, 460 Art. no. 627462		•							
3 COMBINED FISHING/SUN DECK, 530 BR In chequered plate. Can be combined with fishing chair. Art. no. 712027	•								
4 SEAT PAD FOR FISHING/SUN DECK, 530 BR Art. no. 627531		•							
5 SOLAR CELL PACKAGE 1 marine solar panel, 35 W (2A) 1 charge regulator 1 battery box Cables, screws and mounts for the solar panel. Art. no. 712900									•

	530BR	460	445B	445M	445C	400	355	440	410
6 RATCHET STRAP, 3.5 M, STAINLESS STEEL Grey polyester with stainless steel ratchet. Breaking strength 2,500 kg. Art. no. 612500		•	•	•	•	•	•	•	•
7 RATCHET STRAP, 5.5 M Blue polypropylene (with ratchet). Breaking strength 500 kg. Art. no. 612000		•	•	•	•	•	•	•	•
8 TUBE ROD HOLDER, ALUMINIUM Blue aluminium. Holds the rod in place when fishing. Fits on boat rail. Art. no. 623400		•	•		•	•			

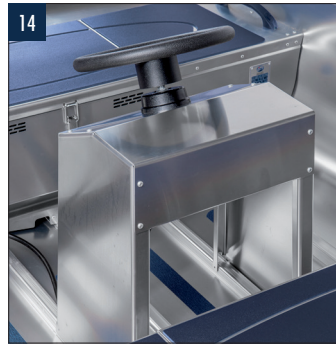

ACCESSORIES

	530BR	460	445B	445M	445C	400	355	440	410
9 THREE-TUBE ROD HOLDER, PLASTIC Black plastic with 3 holders. Standard on 445 Catch. Art. no. 623000	•	•	•	•	•	•	•	•	•
10 MOUNT FOR TUBE ROD HOLDER Mount for tube rod holder (fits to hull). Standard on 445 Catch. Art. no. 623010			•	•	•	•	•	•	•
11 TROLLING ROD HOLDER Holds the rod in place when fishing. Can be mounted and adjusted many ways. Easy to assemble. Art. no. 623100	•	•	•	•	•	•	•	•	•
12 LINDER MOORING PACKAGE SMALL Contains: 4 fenders navy blue (diameter 130 mm, length 370 mm), 4 fenders protection, 4 ropes for fender, 1 anchor 3.5 kg, 1 anchor line 35 m, 2 mooring ropes 6 m, 1 bailer, 1 piece sponge. Art. no. 625000	•	•	•	•	•	•	•	•	•

	530BR	460	445B	445M	445C	400	355	440	410
13 LINDER MOORING PACKAGE LARGE Contains: 4 pcs fender large navy blue (diameter 130 mm, length 560 mm), 4 pcs fender protection, 4 pcs rope for fender, 1 pcs anchor 7.5 kg, 1 pcs anchor line 40 m, 4 pcs mooring line 6 m. Art. no. 627000		•	•						
14 STEERING CONSOLE, CENTRE Mounts on reinforcing profiles. Art. no. 715400									•
15 STEERING CONSOLE, RIGHT-HAND, FROM 2007 Mounts to gunwale and reinforcing profile. Space for battery and box inside the console. Art. no. 717400									•
16 TELESCOPIC OUTBOARD MOTOR HANDLE For better trim when alone in the boat, it is advisable to sit on the centre seat. Length: 700–1,350 mm. Art. no. 620000									• •

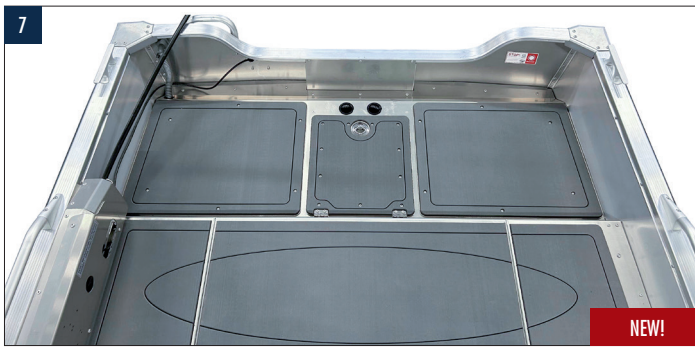
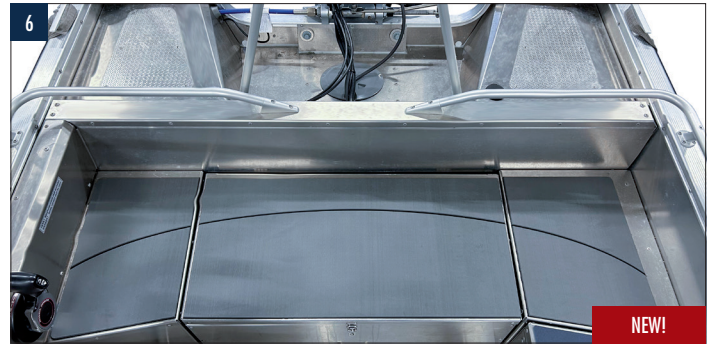
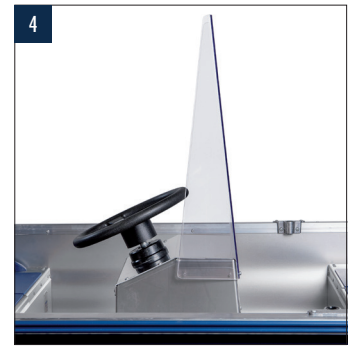

ACCESSORIES

	530BR	460	445B	445M	445C	400	355	440	410
1 WATER SKI PYLON The pylon is easy to remove. The mounts remain on the boat. Art. no. 712530		•							
2 WATER SKI PYLON Art. no. 712500 <i>Cannot be combined with electric motor mount/cover harbour</i>			•						
3 WINDSCREEN FOR SIDE CONSOLE, FROM 2007 Transparent polycarbonate, 5 mm thick. Fits steering console, art. no. 717400. Art. no. 717401						•			
4 WINDSCREEN FOR STEERING CONSOLE, FROM 2007 Transparent polycarbonate, 5 mm thick. Fits steering console, art. no. 715400. Art. no. 714403					•				
5 WINDBREAK FOR DOUBLE CONSOLE Grey acrylic fabric. Art. no. 302463 (From 2015) Art. no. 302469 (Up to 2014)		•	•						

6-7 SOFTFLOOR

Soft surface that offers high comfort, is heat insulating and provides good grip - even when wet. Low weight. High resistance to water and wear and has a long life. Good environmental choice as it is completely recyclable!
Art. no. 627502 (Pic. 6)
Art. no. 627501 (Pic. 7)

8 BAILER

In orange plastic.
Art. no. 604000

	530BR	460	445B	445M	445C	400	355	440	410
6-7 SOFTFLOOR									
8 BAILER	•	•	•	•	•	•	•	•	•

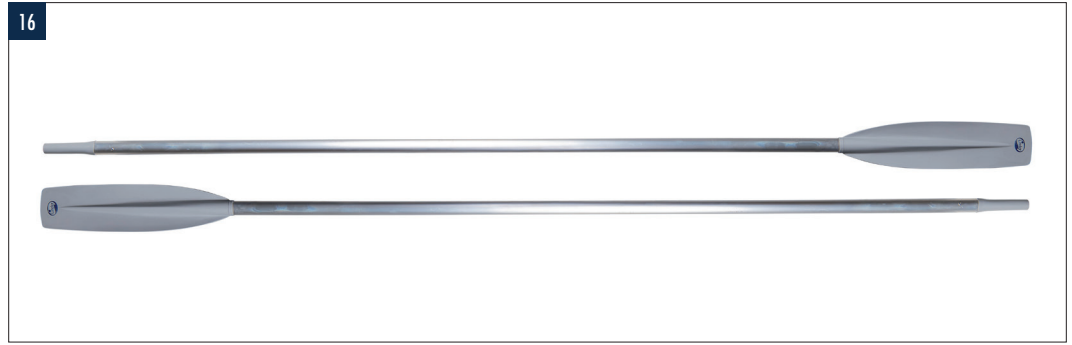

OARS

9 ARTICULATED ROWLOCK (STANDARD)

In aluminium. Suitable for aluminium and wooden oars.
Art. no. 711250¹⁾

10 OAR BLADE HOLDER (STANDARD)

To hold oar in place. Polyethylene foam.
Art. no. 711605¹⁾

11 ALUMINIUM ROWLOCK

Fitted to oar and then inserted in rowlock mount (which is fitted to the boat). Cannot be combined with aluminium oars.
Art. no. 112001¹⁾

12 ROWLOCK / RAIL ROWLOCK MOUNT

Cannot be combined with aluminium oars.
Art. no. 810819¹⁾ Rowlock.
Art. no. 711004¹⁾ Rail rowlock mount.

13 ANGLED ROWLOCK MOUNT

Standard in Linder boats. In aluminium.
Fits safety or standard rowlock.
Art. no. 711001¹⁾

14 BLACK PLASTIC BUSHING FOR ROWLOCK MOUNT

Art. no. 711003¹⁾ Standard.
Art. no. 711608¹⁾ Nov 2004 – Oct 2007.

	530BR	460	445B	445M	445C	400	355	440	410
9			•		•	•	•	•	
10			•			•	•	•	•
11			•			•	•	•	•
12		•		•	•				
13			•			•	•	•	•
14		•				•	•	•	•

15 OAR SLEEVE

Protects oar from wear.
Art. no. 112010¹⁾

16 ALUMINIUM OARS

With plastic blade and handle. (Rowlock not included).
Art. no. 113070²⁾ 7 foot (2.1 m)
Art. no. 113080²⁾ 8 foot (2.4 m)
Art. no. 113085²⁾ 8.5 foot (2.55 m)
Art. no. 113090²⁾ 9 foot (2.7 m)
Art. no. 113100²⁾ 10 foot (3.0 m)

17 OARS

Oars are made of laminated, glued, pine. (Rowlock not included).
Art. no. 115050²⁾ 5 foot (1.5 m)
Art. no. 115060²⁾ 6 foot (1.8 m)
Art. no. 115070²⁾ 7 foot (2.1 m)
Art. no. 115080²⁾ 8 foot (2.4 m)
Art. no. 115085²⁾ 8.5 foot (2.55 m)
Art. no. 115090²⁾ 9 foot (2.7 m)*
Art. no. 115100²⁾ 10 foot (3.0 m)
Art. no. 115110²⁾ 11 foot (3.3 m)
Art. no. 115120²⁾ 12 foot (3.6 m)
*Applies to 460 and 445M with rowlock mount fitted to rail.

	530BR	460	445B	445M	445C	400	355	440	410
15			•			•	•	•	•
16							•		•
17							•		•
		•	•	•	•	•	•	•	•

1) Sold individually 2) Sold in pairs



ALUMINIUM CANOES



INKAS 465L A light and versatile canoe for two people, lakes and rivers. Highly manoeuvrable and perfect even for one person. Simple to load onto a car roof. Suitable for private use. Unsinkable. Three-year guarantee.

Art. no. 465200



INKAS 465 A light and versatile canoe for two people, lakes and rivers. Simple to load onto a car roof. Highly manoeuvrable. Perfect for private use, young people and daily rental. Unsinkable. Three-year guarantee.

Art. no. 465000



INKAS 495 Just the right size for two people with plenty of gear. Suitable for weekend trips and rental. Unsinkable. Three-year guarantee.

Art. no. 495000



INKAS 525 The only canoe approved for three people. From stable family-canoe to adventure-canoe, Inkas 525 can be used on the sea and in rivers. Suitable as week-long rental canoe with plenty of room for gear. Unsinkable. Three-year guarantee.

Art. no. 525000



	LENGTH (cm)	WIDTH (cm)	WEIGHT (kg)	BOW/STERN HEIGHT (cm)	LOAD CAPACITY (kg)	MAX. NO. PEOPLE	HULL THICKNESS (mm)
INKAS 525	525	90	38	35	400	3	1.25
INKAS 495	495	90	36	33	400	2	1.25
INKAS 465	465	85	33	33	340	2	1.25
INKAS 465L	465	85	28	33	340	2	1



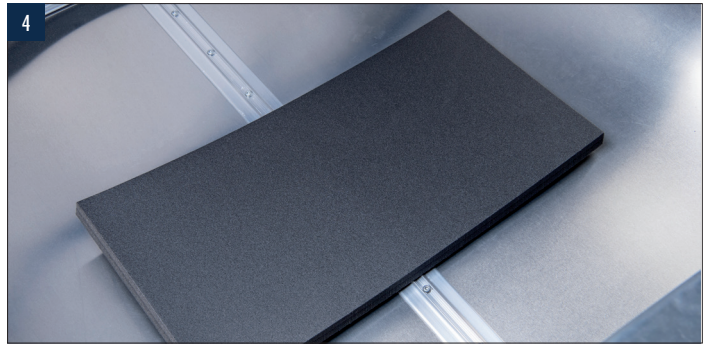
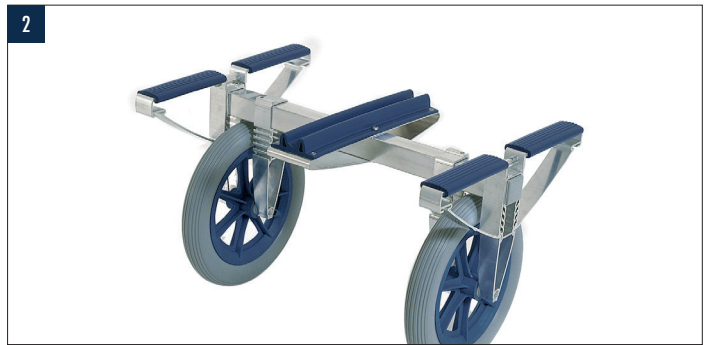

ACCESSORIES

	525	495	465	465L
1 INKAS STRAP, 3.5 M With buckle. Art. no. 612350	•	•	•	•
2 INKAS CANOE CART Strong aluminium design. Solid tyres and fixed bearings. Weight: 6 kg. Load capacity: 100 kg. Art. no. 406000	•	•	•	•
3 INKAS CANOE CART, COLLAPSIBLE Strong aluminium design. Solid tyres and fixed bearings. Weight: 6 kg. Load capacity: 100 kg. Art. no. 407000	•	•	•	•

	525	495	465	465L
4 KNEE/SEAT PAD Black, heat-retaining polyethylene foam. 50 x 25 x 2 cm. Art. no. 606000	•	•	•	•
5 MOTOR MOUNT Produced in aluminium. Easy to fit. Suitable for electric motors. Art. no. 705525	•	•	•	•
6 PACK SACK (59 LITRES) Watertight pack sack with carrying handle. Easy to close. Art. no. 609000	•	•	•	•
7 PACK BIN (60 LITRES) With sealing lid and handle. Art. no. 610000	•	•	•	•

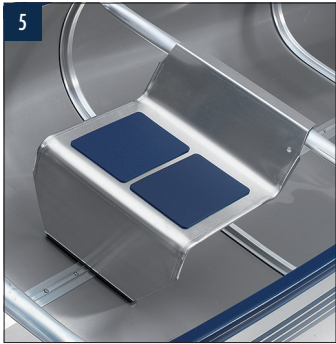
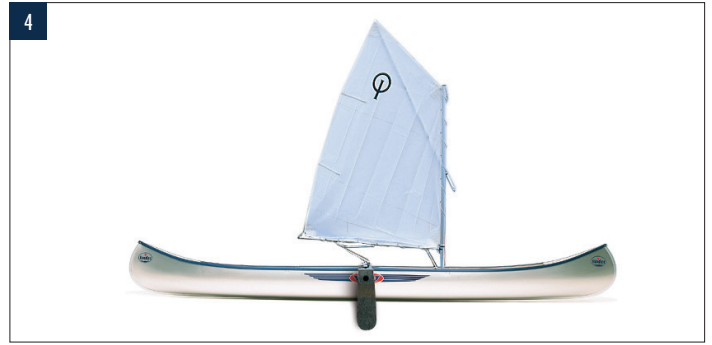

ACCESSORIES

1 PONTOONS

Inflatable pontoons for extra stability (fishing, disabled, etc.).
Length: 1,370 mm. Diameter: 220 mm.
Art. no. 706525

525
495
465
465L

• • • •

2 ROWING RIG

Easily mounted on the rail. Rowlock and oars are additional.
9-foot oars are recommended. Weight 5 kg.
Art. no. 707525

• • • •

3 BACK SUPPORT

Plywood and steel tube (painted grey) backrest. Attaches to seat.
Sit more comfortably!
Art. no. 605000

• • • •

4 SAIL EQUIPMENT

Pram sail (3.5 m²) and complete rigging.
Art. no. 708525

• • • •

5 REMOVABLE SEAT

With insulated seat pads. To be hung on the cross support.
Seat height 20 cm.
Art. no. 700200

525
495
465
465L

• • • •

6 CANOE SEAT, ALUMINIUM, FOLDING

Folding aluminum canoe seat. Size 36x35 cm and 33 cm deep.
Seat height approx. 5 cm from the bottom.
Soft tufted covers for better sitting comfort.
Placed in the bottom of the canoe.
Art. no. 601000

• • • •

7 SEAT

Art. no. 700104 Aluminium seat stern, no. 3
Art. no. 700106 Aluminium seat stern, no. 3
Art. no. 700105 Aluminium seat bow, no. 4

•
• • •
•



PADDLE	525	495	465	465L
8 INKAS PLASTIC PADDLE WITH ALUMINIUM HANDLE Blade and knob of strong polypropene. Blade width: 200 mm. Weight: approx. 850 g. Art. no. 114130 130 cm Art. no. 114140 140 cm Art. no. 114150 150 cm Art. no. 114160 160 cm Art. no. 114170 170 cm Art. no. 114180 180 cm				
9 INKAS WOODEN PADDLE Manufactured from very high quality fir. Blade width: 150 mm. Weight: approx. 850 g. Art. no. 104100 100 cm Art. no. 104125 125 cm Art. no. 104140 140 cm Art. no. 104150 150 cm Art. no. 104160 160 cm Art. no. 104170 170 cm Art. no. 104180 180 cm				
10 NEW INKAS DOUBLE PADDLE, DIVISIBLE Divisible double paddle that provides powerful paddle strokes. Length 240 cm. Blade of fibrylon and shaft of aluminum. Made in France Art. no. 110240 240 cm				

LIFE JACKETS

11 INKAS CANOE JACKET

For swimmers using Canadian canoes. CE approved. Comfortable and hard-wearing.

Art. no. 201030 30–50 kg

Art. no. 201050 50–70 kg

Art. no. 201090 70 kg upwards

12 INKAS CANOE JACKET

For swimmers using Canadian canoes. Dirt-repellent polyester weave, waistband 160 cm

Art. no. 201100 40–130 kg

13 BALTIC LIFE JACKET

For non-swimmers and swimmers in coastal/inland waters. CE approved.

Good fit. With split front for greater mobility and comfort.

Art. no. 205010 3–10 kg

Art. no. 205015 10–20 kg

Art. no. 205030 15–30 kg

Art. no. 205040 30–40 kg

Art. no. 205050 40–50 kg

Art. no. 205070 50–70 kg

Art. no. 205090 70–100 kg

Art. no. 205100 100 kg upwards

14 LINDER BUOYANCY AID

For swimmers. CE approved. Convenient to use.

Art. no. 206050 30–50 kg

Art. no. 206070 50–70 kg

Art. no. 206090 70–90 kg

Art. no. 206100 90 kg upwards

15 INFLATABLE, LINDER LIFE JACKET

Winner 150. Blue. Buoyancy: 150 N.

For annual inspection and maintenance, see www.baltic.se

Art. no. 201200 40–150 kg



Visit www.linder.se
for lots more information,
accessories and good advice.

Linder Aluminiumbåtar AB
Kanotleden 5
SE-362 32 Tingsryd
Sweden

Tel. +46 477 190 00
Email: info@linder.se
www.linder.se



Aluminium boats